

DROP-IN CIRCULATOR

Features

- Low Cost and **RoHS** Compliant
- Industry Standard 0.75 Inch Drop-in package
- Designed for Wireless Telecom Systems
- 50 Ohms Characteristic Impedance

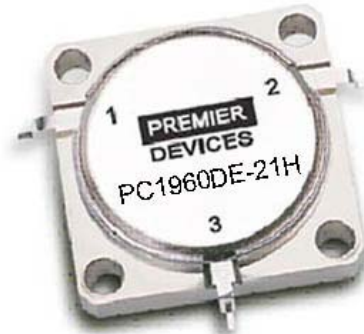

Description

The PC1960DE-21H is a small low cost drop-in circulator designed for applications in high performance linear power amplifiers for wireless base stations. These circulators feature a robust construction for high reliability with excellent IMD performance. These circulators are built Lead-Free and RoHS compliant. CCW rotation and special tab offsets available on request. S-Parameters are also available on request.

Specifications

Parameter	Minimum	Typical	Maximum
Frequency Range (MHz)	1930		1990
Insertion Loss (dB)		< .22	.30
Isolation (dB)	20	>30	
Return Loss (dB)	20	>25	
IMD (dBc) 2T x 37.5 Watts	-70	-75	

Absolute Maximum Ratings

Parameter	Maximum
Power	100 Watts CW
Operating Temperature	-40 to +85 °C
Storage Temperature	-40 to +85 °C

Note: Typical values represent Mid-band performance @ 25°C.

Schematic

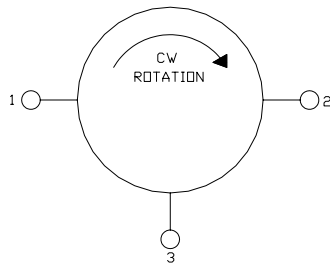

Package

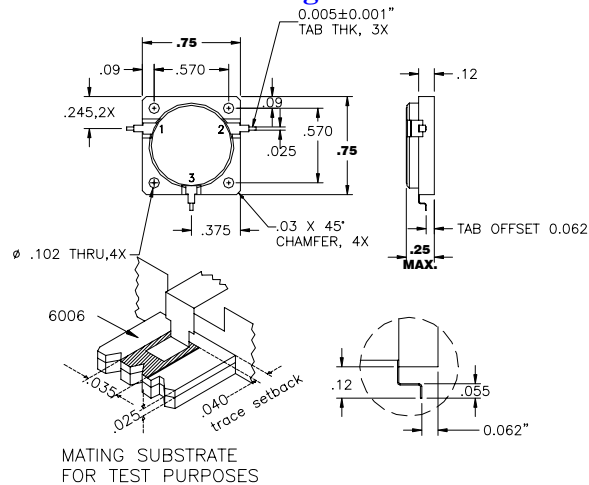

Pin Functions

Function	Pin
INPUT	1
OUTPUT	2
TERMINATED	3

Typical Test Data – Insertion Loss

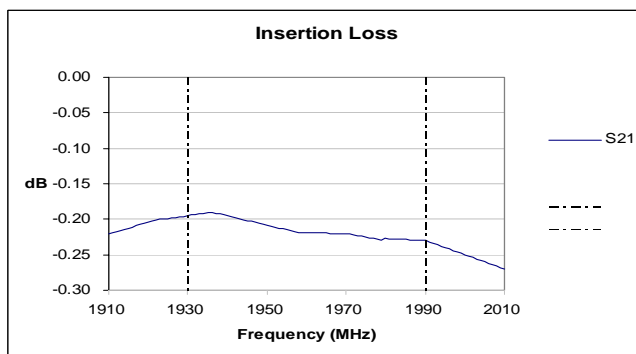

Typical Test Data – Return Loss and Isolation

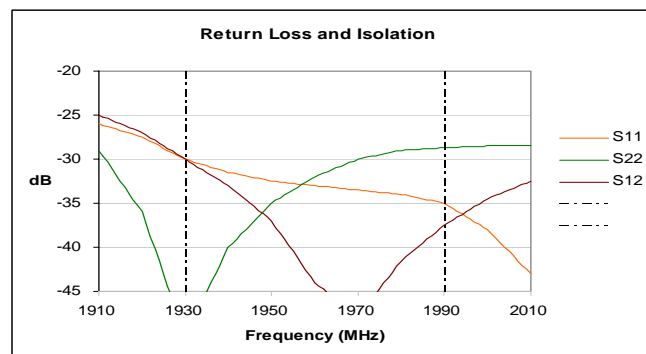

Specifications and information on this data sheet are subject to change without notice.